

PatternMaker Software™

Women's Collection Vol. 1

Designer: Leena Lahteenmaki

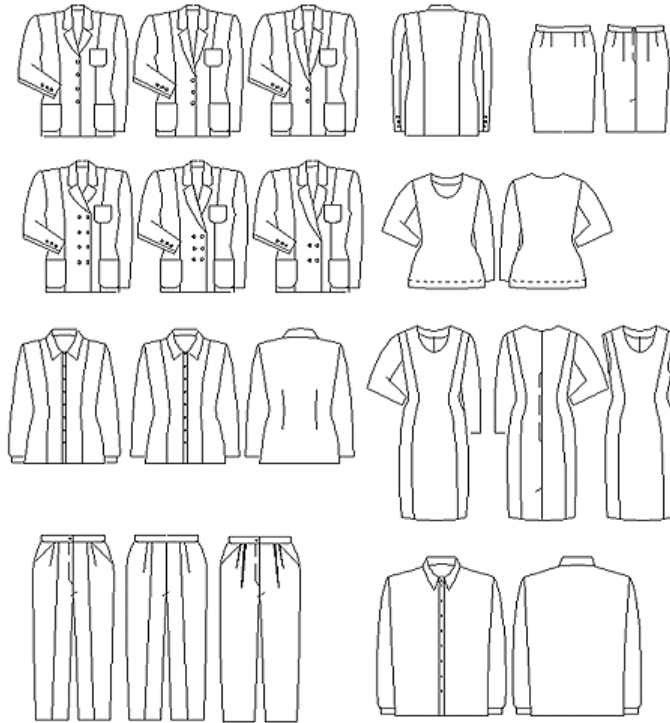

INTRODUCTION

The women's garment macros have been designed to create an entire wardrobe from a single set of measurements. The designs are simple basic patterns which look good on most figures. Just type in your measurements, and the program draws a complete pattern for you.

This package includes macros for making a wide range of women's garments. After you learn to use the PatternMaker program, you can save time by letting the macro create the basic garment for you to modify to your own design or you can draft your own patterns from scratch.

WHAT ARE MACROS?

Each PatternMaker macro is a small computer program which is run by PatternMaker. You will be asked to make some style choices and type in your measurements. The program then does some calculations and draws a garment pattern. These are complete patterns, ready to cut out and sew. All of these macros have been tested in commercial use for a wide range of sizes and measurements. Once you make a pattern from a macro, you can change it to create your own individual garment.

Most of these garments require an intermediate or advanced level of sewing skill. If you do not already know how to assemble a garment, sew buttonholes, etc., you will need to refer to a general sewing text as well as these instructions. For beginners, the Skirt macro is the easiest to make. For advanced sewers and pattern makers, the Bodice serves as a sloper, or fitting shell, to design your own patterns.

PatternMaker has many patternmaking features, and the macros are a good way to start learning

about them. Use this booklet to get started making patterns. Practice the tutorials to see how some of the PatternMaker commands are used, and read the User's Manual to learn the details.

OVERVIEW

Here's what you need to do to make your new set of garments with PatternMaker:

- **Take your measurements.** Everything else depends on having good measurements. The measurement form included in this package provides detailed instructions on how to take the measurements. Read the instructions carefully, and be very careful when taking the measurements.

If you want to make clothes for more than one person, photocopy the measurement form (both sides) for each subject. Don't write on the original before you copy it! You will use these measurements for all the macros, so keep the form in a safe place for future reference. Don't forget to fill in the name and date – you may not remember whose measurements these are a few months from now.

- **Make a test muslin.** This is especially important the first time you use the macros to make sure your measurements are good. Use the **LBODICE.MAC** or **LPANTS.MAC** macro to make a basic fitting muslin. If it doesn't fit right, adjust your measurements and try again.
- **Run the macro for the garment you want.** PatternMaker will ask you for some measurements, which you will type in. Then it will draw the pattern. If you already have a pattern on the screen, the new items will be added to it. You can now use all of PatternMaker's various features to modify your pattern, if you wish. Or you can just print it out and sew it.
- **Arrange for printing.** You may need to use the MOVE and ROTATE commands to arrange the pieces for the most efficient printing.
- **Print your pattern.** If you have a small desktop printer, you will need to tape the pages together. The pages will be marked to make it easy to assemble them.
- **Cut out and sew your new garment.** This booklet gives you most of the sewing instructions you need, but always rely on your common sense. We hope you enjoy your new clothes!

RUNNING A MACRO

When you first start the PatternMaker program, you will see a blank drawing area. To run the macros, select the MACRO command from the File menu, or click on the icon which has the word MAC. (Users of PatternMaker Basic should select OPEN from the File menu, or click the OPEN icon.)

A dialog box will ask you to select a file. Each macro is a separate file in your PatternMaker directory. Descriptions of each macro are given later in this book. The file names in this collection are:

- LBODICE
- LBLOUSE
- LCOLLARS
- LDRESS
- LJACKET
- LPANTS
- LPULLOVER
- LSHIRT
- LSKIRT

Click on the name of the file, and then click "OK". It may take a few seconds for PatternMaker to load the macro.

You will now see a series of dialog boxes which ask questions and offer choices. The dialog boxes are different for each macro. To continue through the macro, you must use your mouse to click on one of the options. If you click "Cancel," or if you click "OK" without making a selection, the macro will abort and you will be returned to the drawing screen. Also, be aware that you cannot move backwards through the options. You may wish to write down which options you choose. Refer to the enclosed pages for a "map" of the macro options.

After you've made your garment style choices, a dialog box will ask you for the measurements. The illustration at the right shows the first of two measurements dialog boxes. Fill these in from your

measurement chart. Remember to use decimal numbers:

1/8 -----	.125
1/4 -----	.25
3/8 -----	.375
1/2 -----	.5
5/8 -----	.625
3/4 -----	.75
7/8 -----	.875

Be careful to enter the right numbers in the right spaces. When you are ready, click "OK" or press the <Enter> key.

You may have to wait a minute for the macro to run, especially if you don't have a fast computer. You will know the macro is done when the hourglass cursor changes back to an arrow and the word **Command:** appears on the prompt line.

BASIC BODICE	
Neck	Bust
15.5	37.75
Waist	Abdomen
30.75	37.50
Hip	Bust span
40.25	8.25
Bust height	Waist height
14.5	21.00
Back length	Back width
16.25	14.75
<input type="checkbox"/> OK	<input type="checkbox"/> Cancel

IF YOU CANNOT SEE THE PATTERN PIECES, OR IF YOU ONLY SEE PART OF THEM, PRESS THE <END> KEY TO VIEW ALL THE PIECES IN THE DRAWING.

Look at your macro

The macro will draw your new pattern in the drawing area. If you already have a drawing, the new items will be added to the existing ones. To zoom out and see the entire pattern, press the <END> key. To zoom in, use <F2> or <F3>. Use the arrow keys to move up, down, left, and right. (See the PAN and ZOOM commands in the Help file.)

ARRANGE YOUR PATTERN

Now, you can use the PatternMaker editing features to make changes to your pattern. PatternMaker has tools to make almost any alteration. Some simple changes you may want to make before you print are:

- Erasing an object (ERASE command)
- Moving an object (MOVE command)
- Rotating an object 90 or 180 degrees (ROTATE command)
- Label your pieces (TEXT command)

Refer to the User's Manual or the Help file for detailed instructions on these commands.

IF YOU MAKE A MISTAKE

If you make a mistake in one of the above operations, you can use the UNDO command to undo your last change. The Undo icon looks like a letter "U." If you make a really big mistake, you can use the New command (on the File menu) to start all over. Luckily, this isn't hard to do.

READ THE MANUAL

Here are some other commands you'll want to learn before long. Look them up in the User's Manual or the on-line Help system.

- MOVE VERTEX to adjust shapes
- SET LINE to draw dotted lines
- COLOR to draw in different colors
- GROUP to keep groups of things together
- DIM and SET/MEASURE DISTANCE to check measurements
- POLY to draw your own objects
- COPY and MIRROR to copy objects

- LAYER to hide things from view

Note: These commands are available only in the Home Version and higher.

PRINT YOUR PATTERN

Before you print out your pattern, you should use the MOVE command to arrange the pieces in the most efficient way you can, to save paper. The pieces aren't arranged for you, because the best arrangement will depend on your measurements and the size of the printer you have. If possible, arrange the pieces to fit within a rectangle no wider than your printer's page size. Make sure you leave enough room for seam allowances, if you didn't already add them.

We assume you already have your printer set up and working. PatternMaker works with any Windows-driven printing or plotting device. If you have a printer with tractor-feed paper, print in Landscape mode to make the pages connect in the correct order.

See "Printing a pattern" in the Help file for details about the various Print commands, and "Assembling a printed pattern" for instructions on putting the pages together.

TESTING MEASUREMENTS WITH TEST GARMENT

To test that you have taken the measurements correctly, it is strongly advised that you make muslins from the basic bodice and pants macros and try them on. This muslin will make your own customized fitting shell. Advanced sewers can use this as a basis for new patterns. Sew it with actual seam allowances and try on. Close with pins at front and center.

These are the most important measurements for the macros to work well:

- back width
- front length
- back length

To see if these are taken correctly, run macro **LBODICE.MAC** (see the following section "How to run a Macro") with your measurements.

Back piece should be as in picture; shoulder tip (1) somewhat outside back armscye edge (2). Line from point 1 to point 2 should never curve outwards (3). If this should be the case, recheck your shoulder length measurement and your back width measurement.

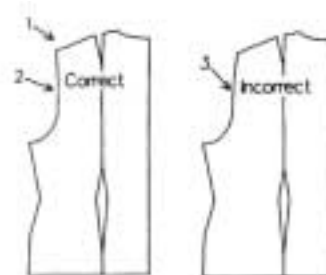

Front shoulder slope can vary depending on front and back lengths and on size of bust. The angle of the shoulder line may be different than what you are accustomed to, because the macros are designed to vary this angle to account for bust size. A steep shoulder line indicates a large bust (4). If you don't have a large bust, check front and back length measurements. Either front measurement is too much or back measurement is too little.

If front shoulder slope is almost horizontal (5), you must have long back compared with front. This is the case i.e. when your back is rounded or when you have a flat bust. If not, check front and back length measurements. Either front measurement is too little or back measurement is too much.

If you don't have any of these properties, your basic bodice should look something like picture (6).

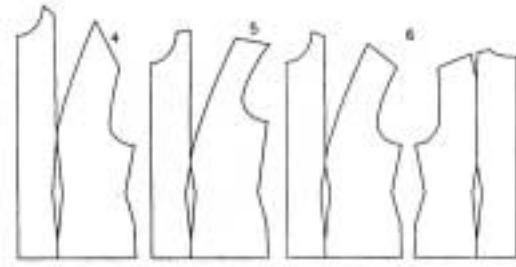

MAKE A MUSLIN WITH BASIC BODICE PATTERN

The basic bodice **LBODICE.MAC** is a fitting shell, not an actual garment. Use it to make your own customized fitting shell (sloper).

Note:

- bodice should be very tight, like a “second skin.” Do not add any ease in the measurements, since this is done by each pattern macro.
- you cannot make any garments with this pattern (with the exception of knit or elastic fabrics when you, however, might need to do something to the size of the neck opening). This is a base pattern for further designs of your own for which you have to add the needed ease for each garment.
- sleeve cap has ease which is to be shrunk when sewing sleeve to garment. Some fabrics are not easy to shrink, therefore do not mind in this phase if there seems to be too much ease in sleeve cap.

Things to check for:

- horizontal levels are correct (bust, waist, hip) front/back
 - if bust is not in correct place, change neck-bust measurement
 - if waist is not in its correct place, change front length and/or back length (note that you might not need to change both)
 - if hip is not in its correct place, change hip height measurement
- back width is correct
- shoulder length is correct
- width is correct on bust, waist, abdomen and hip

If your body is asymmetrical:

You will have to check separate measurements for each side of your body. This can be done with test bodice, too.

If you have to increase or decrease shoulder slope, you cannot do it by changing measurements. Make separate patterns for each side and adjust with PatternMaker's MOVE VERTEX command. Once you have measured the needed amount to be corrected, you can use the same correction with all subsequent garments.

What if it still doesn't fit?

If your bodice is still a poor fit after checking the above:

- Recheck your measurements. Make sure that you are measuring at the points indicated in the instructions and the illustration.

Sometimes, more adjustments will be necessary. For some measurements, it's hard to judge the correct points to take the measurements until you've done it a few times. For a few people, you will need to modify the measurements even though they were taken correctly. Here are some things to try:

- **Shoulder length.** Adjust this if the shoulder seam forms an odd angle with the armhole. Increasing this will give more of a curve in the upper armhole and will make a sharper angle where the armhole meets the shoulder seam. This can be changed by up to ½ inch (1 cm) from the measured value.
- **Back width.** Adjust this if the armholes are not in the right place. Increasing the back width transfers fullness from the chest to the back and moves the armholes forward, and vice versa. For instance, if the bodice is tight across the chest and puffs out in back, you should decrease the back width. Choosing the correct points for measuring the back width requires some practice, so you may have to make some adjustments here the first few times you do it.
- **Neck.** Increasing the neck measurement makes the neckline larger, of course. It also makes the shoulder line steeper. You may need to adjust this because it's easy to put the measuring tape a little bit too high when measuring, which will make the neck measurement too small.
- **Crotch depth.** This is a critical measurement in fitting pants. It's better to make this too large than too small, because any excess will come out in the waist height and can be corrected when you sew it.

Try your changes on the computer

Before you start sewing a muslin with your modified measurements, try your changes on the computer screen. Use the COLOR command to draw the pattern in two different colors, one with the old measurements and one with the new, and compare them. You can learn a lot about pattern construction this way. One of the great advantages of using a computer is that you can try out more modifications than would be possible if you had to draft each pattern by hand.

Does it look right?

If your new, modified pattern looks better, it probably is. If it looks wrong, it probably is. Keep experimenting until you have a pattern that corrects all the fitting problems in your first muslin.

When you have determined what changes will make your bodice fit correctly, write down the new measurements and make another fitting muslin. If this fits properly, save the corrected numbers on your measurement chart.

Important – Use the corrected measurements for all macro patterns. Remember that the purpose of making the fitting muslin is to find the correct values for the measurements on the chart. Once you have got these right, use the same values for all the other macros. Don't use the old numbers. Ease for each pattern is added by the program.

MAKE A MUSLIN WITH BASIC PANTS PATTERN

Make a test garment with basic pants pattern i.e. without pleats in front. Check that the pants fit. If they don't fit properly, change the recorded measurements accordingly and you will have a well-fitting trouser pattern. Pants fit is snug, something like jeans. If you want pants with more ease, use pleated version or else add to measurements of waist, abdomen and hip.

Things to check for:

- waist line is correct (if waist of pants is too low, add to crotch depth measurement and vice versa)
- width is correct on waist, abdomen and hip (if it is not, increase or decrease measurements accordingly)
- pants fit at front crotch. Double-check the crotch depth vertical measurement. If necessary, you can correct the situation by moving front crotch end to make it longer or shorter. Caution: Moving the crotch end or shaping the crotch is a difficult change for the inexperienced sewer, and may cause surprises.

- pants fit at back crotch (if they don't, you can correct this by moving back crotch end to make it longer or shorter)
- you can add ease to future pants by increasing the waist, abdomen or hip measurements

MAKE A MUSLIN WITH BASIC SKIRT PATTERN

Make a test garment also with skirt basic pattern. Check that the skirt fits. Skirt should fit quite tightly. If you want to have a skirt with more ease, add to measurements of waist, abdomen and hip.

Things to check for:

- waist line is correct (if waist of skirt is too low, add to abdomen height measurement, and vice versa)
- hip line is correct (if hip of skirt is too low, decrease hip height measurement, and vice versa)
- width is correct on waist, abdomen and hip (if they are not, increase or decrease the measurements accordingly)

WOMEN'S GARMENT MACRO DESCRIPTIONS:

BASIC BODICE (LBODICE.MAC)

This is the only pattern which you cannot use as it is because it has too little fitting ease. Sew a muslin with this pattern to see that your measurements have been taken correctly. Basic bodice should be like a "second skin" to you. If it does not fit, check the measurements. If the basic bodice fits perfectly on you, you can make any other pattern with the same measurements with peace of mind. All other macros derive from this basic pattern. Basic bodice has a circumference ease of 3¼ in (8 cm) on bust, 2½ in (6 cm) on waist, and 1½ in (4 cm) on abdomen and hip.

PULLOVER (LPULLOV.MAC)

This is a fitting pullover without darts or collar. With collars macro (COLLARS.MAC) you can draw a collar for it, if you want to. First change neck opening similar to that in basic bodice, but 3/8 inch (1 cm) wider for each 1/4 neck opening and 3/8 in. (1 cm) deeper. Eases "minimum" and "normal" are only meant to be used with knit or elastic fabrics. Which ease to use depends on how elastic the fabric is.

FITTED BLOUSE (LBLOUSE.MAC)

Blouse is a fitted garment, either with princess seams (to shoulder) or bust darts, with three ease options. It can be made with or without shoulder pads. There are three sleeve options to choose from: fitting sleeve which has no cuff, shirt sleeve with button cuff, or dropped sleeve. There is a convertible collar. If you want to, you can draw a different kind of collar for this garment with the collars macro (COLLARS.MAC) using the measured garment neck length.

If you want to sew a loose-fitting blouse from this pattern, leave waist darts unsewn. You can also use this pattern to develop a pattern for a garment like a men's vest. Choose maximum ease option. Cut front neck and hem according to your wishes and erase sleeves. Draw facings.

SHIRT (LSHIRT.MAC)

Shirt is a boxy, loose-fitting garment like a men's dress shirt, with three ease options. There are three

sleeve options to choose from: fitting sleeve which has no cuff, shirt sleeve with button cuff, or dropped sleeve. Shirt has either a two-piece shirt collar or one-piece convertible collar. It can be made with or without shoulder pads.

This pattern can also be used for other boxy garments such as tunics, T-shirts, sweaters, blazers, etc.

JACKET (LJACKET.MAC)

Woman's suit-type jacket with or without shoulder pads. The cut is princess-style, with seams to shoulders.

You have options for single- or double-breasted jacket, with three ease options. Minimum ease creates a close-fitting jacket to be worn over underwear. Under a medium ease jacket you can wear a blouse. Maximum ease jacket is to be worn indoors in winter or outdoors in spring, summer, and autumn. It is meant to be sewn of thick (wool) fabric. A light sweater can be worn under it.

Jacket also has three sleeve options (one-piece, two-piece, or dropped sleeve), and three lapel heights: low (from waist), normal (middle of waist-bust), and high (from bust).

Jacket has shoulder princess seams in front and back pieces. You can easily change the seams to armhole by moving upper end of seams to armhole and closing shoulder darts. Try making other kinds of designs by moving darts.

Jacket length can be freely determined, so this macro can also be used to create patterns for a jacket-style dress.

Jacket has a traditional tailored collar. By joining collar to front piece you can change the jacket to shawl collar jacket. Use Move and Join commands to do this. Shape collar outline according to your wishes. If you want to change jacket neck to jewel type you can correct the neck opening by comparing it with the neck opening of a basic bodice. Make neck line 3/8 inch (1 cm) wider (per 1/4 neck) and 3/8 inch (1 cm) deeper if you do this. You can use collars macro to create a different kind of a collar. Change neck opening as for jewel neckline before attaching one of these collars.

You can also change neck opening to V-shape. When doing so, do not make it completely straight, but curve the edges a bit.

DRESS (LDRESS.MAC)

Dress has three ease options, with either fitting sleeve or dropped sleeve. Fitting sleeve is close-fitting, with narrow wrist and a dart at elbow. For a button slit, transfer dart to wrist. If you are using elastic fabric, you can omit the elbow dart; just stretch sleeve seam at front edge to fit it to back edge. Dress can be made either with or without shoulder pads.

Dress has dividing seams in front and back pieces. You can change the design of the dress by moving shoulder darts as described for jacket.

The dress has a jewel neck opening. There is a 30 cm long zipper at back center seam at waist. By changing the hem length, you can use this macro to create dresses from mini to full length. There is a back slit at hem. For short dresses (above the knee) or of elastic fabrics, omit the slit.

SKIRT (LSKIRT.MAC)

Skirt is a straight basic skirt with back slit. It tapers slightly toward the hem. The skirt has either one or

two darts at front and back waist, depending on difference between waist and hip measurements. By changing the hem length, you can use this macro to create skirts from mini to full length.

PANTS (LPANTS.MAC)

Slacks have options for normal fitted version with darts at front and back waist, and a version with a pleated front. Version with darts has further option for

COLLARS (COLLARS.MAC)

This macro draws a two-piece shirt collar, shirt mock-collar, and two different kinds of convertible collars. Use these collars as variations on the standard collars. Convertible collars have pointed and rounded versions. Before you run this macro, run the macro for the garment you will use it with and measure the neckline length with the Set/Measure Distance function. The collar measurement you enter in the dialog box is the circumference of the garment neck, not the actual body measurement.

These collars can also be used for jackets in which case you might want to make them about 1 cm wider on outer edge. Two-piece shirt collar's lower part can also be used separately for Chinese collar.

ABOUT EASE

Patterns cannot be drawn exactly according to your body measurements because you could not move in the finished garment. Also, fashion determines how much ease there is in certain garments. Jackets, dresses and blouses, for example, are rather tight-fitting and body-hugging nowadays. A few years ago, jackets used to be boxy and straight.

The amount of ease calculated for PatternMaker patterns is moderate, according to prevailing fashion. Ease is also added for shoulder pads, if you have chosen the shoulder pad option when running the macro.

Ease for basic patterns (Basic Bodice, Skirt and Pants) is predetermined and cannot be changed. They are close-fitting garments with only the needed fitting ease added.

If you want to add or decrease ease to these garments, cut body, pants or skirt pieces vertically in two and move parts apart from each other or on top of each other to get the desired result. Don't add or decrease anything to side, armhole or sleeve seams. This is also the technique to be used, if you want to add ease to a jacket to change it to an overcoat. Start from maximum ease version jacket. Pants and skirt can be enlarged also by adding space to (only) side seams.

The basic bodice is to be used as a basis for your own designs and you have to add the needed ease for fitting and style yourself. Basic bodice is not to be used as-is for any garment. It will fit like "a second skin."

Other garment patterns have three ease choices:

Minimum, Normal, and Maximum. Be sure to notice the numbers given in the Ease dialog box. They will tell you how much ease is to be added. "Normal" ease for the Lshirt macro is not the same as "Normal" ease for the Lblouse.

You should always make the first garment with normal ease. This is good for most cases. It contains enough wearing ease as well as the ease needed for garment design. Don't add anything to your body measurements – the program calculates the needed ease. Garment patterns drawn with PatternMaker macros are ready to be sewn as they are.

Here are some ideas of how to use other than normal ease.

Minimum ease:

- garments of very thin fabrics
- close-fitting garments and evening dresses
- garments made of elastic fabrics
- closely fitting sleeveless dresses
- underwear

Maximum ease:

- garments of thick fabrics
- jackets of thick wool fabrics for outdoors use
- garments for leisure use
- loose-fitting garments like (tunics, T-shirts, sweaters etc.) outer garments to be worn over other garments

You might want your garments to have more or less ease than normally used. Once you are familiar with the patterns the macros create, you can use maximum or minimum according to your wishes. By testing different eases, you will learn to use them for many purposes. (Keep in mind that the type of fabric you choose will also affect the amount of ease that will be appropriate.)

You should not change your actual body measurements in order to increase or decrease ease. It won't work. You don't know all the measurements which have to be changed or cannot change them as the program calculates some measurements for you.

EASE CHART

Ease is normally described by giving ease at bust circumference. There is also ease at other places such as at neck circumference, back width, armscye depth, shoulder and sleeve length, etc. These eases are not given in the following table, but the differences correspond to bust ease.

Garment	Minimum	Normal	Maximum
Basic Bodice	--	+ 3-1/4" (8 cm)	--
Pullover	- 7/8" (2 cm)	+0 cm	+ 3-1/4" (8 cm)
Blouse	+ 4" (10 cm)	+ 4-3/4" (12 cm)	+ 5-1/2" (14 cm)
Shirt	+ 5-1/2" (14 cm)	+ 6-3/8" (16 cm)	+ 7-1/8" (18 cm)
Jacket	+ 4" (10 cm)	+ 4-3/4" (12 cm)	+ 5-1/2" (14 cm)
Dress	+ 4" (10 cm)	+ 4-3/4" (12 cm)	+ 5-1/2" (14 cm)

Garment	Waist	Abdomen	Hip
Skirt waist	+ 7/8" (2 cm)	+1-1/4" (3 cm)	+1-1/4" (3 cm)
Pants waist	+ 0 cm	+ 1-5/8" (4 cm)	+ 1-5/8" (4 cm)

SEWING INSTRUCTIONS

FOLLOW THESE STEPS FOR WORRY-FREE CONSTRUCTION

GENERAL INSTRUCTIONS

- When you buy your fabric, ask how much it will shrink when washed. In all cases, when the fabric is

washable and when you are not sure that the fabric won't shrink, it is safe to wash and iron it before cutting. Don't forget to preshrink lining as well.

- Cut pattern pieces on folded fabric, right side of the fabric folded inwards. Make the necessary marks on the fabric with chalk or pencil. If the fabric is plaid, striped or checkered, align the hem lines at the same point on the repeating pattern. For sleeves, the repeating pattern should match where the bottom of the armhole and bottom of sleeve cap meet. Vertical centerline of sleeve should be placed at a vertical stripe or at center of a plaid square. Jacket, blouse and dress front center should be placed the same way.
- Transfer notch marks from your pattern to the fabric by cutting snips (depth 1/4 inch/5 mm) into seam allowances. When joining garment pieces, place corresponding notch marks in the two pieces together.
- Cut and iron interfacings onto under collars, facings, waist bands, slit facings, blouse and shirt button extensions and sleeve cuffs. If you use interfacing at jacket's hem seam allowance, you get a neat hem.
- If you sew a patch pocket and don't line it, fasten interfacing to it also. Woven interfacing gives the best results. The macros draw all facings on top of the garment pieces, with dashed lines. If you want to print them apart from the pieces, use the Move command to move them before printing.
- Cut lining along with garment patterns without space for facings (but remember to add seam allowances) and hem seam allowances. Do not cut lining for collars. Lining fabric usually is not as elastic as garment fabric, so cut it with about 1/8 inch (0.3 cm) wider seam allowances than for the garment pieces.
- Use the longest possible machine stitches for basting. It is quick and the stitches can easily be removed.
- The macros make the patterns without seam allowances. If you want to add seam allowances, use PatternMaker's Draw Offset and Draw Seam Allowances commands. The suggested seam widths are 3/8 inch (1 cm) for most seams, and 1 - 1/2 inch (4 cm) for hems and sleeve ends without cuffs. When you are sewing your first garment with PatternMaker patterns, add extra seam allowance so that you can make corrections to the garment if it should be necessary.
- You will get the best result if you always press seams and darts as you sew. First iron seams or darts flat without turning them to either direction. Then press them towards center, side seam towards front. Two-piece sleeve seams are both pressed towards shoulder mark. Use a steam iron. If you press seams from right side of the fabric, use pressing cloth if necessary.
- Edgestitching gives a well-finished look to garment, but only if it is straight and even. Long stitches of 1/4 inch (4-5 mm) look best in edgestitching. Sew edgestitching only after you have ironed the seam.

HOW TO FASTEN WAISTBAND to skirt or pants

1. Iron interfacing to wrong side of waistband. Overlock edges. Fold waistband lengthwise, right sides out, and press. Sew one horizontal edge of waistband to garment, right sides together, (1). Space for button and buttonhole extension extends beyond center front mark at each end of the band. Garment's waist should always be slightly larger than waistband. Easestitch garment waist to fit waistband.

2. Fold waistband lengthwise, right side inside, and sew across one end (buttonhole end) (2). Cut corners and turn waistband right side out. Press seam allowance upward (raw edges of seam will be inside waistband when finished).
3. Fold seam allowance of waistband in about 2 inches (5 cm) from each end but leave rest of waistband seam allowance flat (flat makes it easier to catch when sewing through from the right side, but leaves the raw edge on the wrong side of the skirt instead of tucked into the waistband). Stitch on right side of garment along first stitch line (4) called "stitch in the ditch." Sew button hole and fasten button.

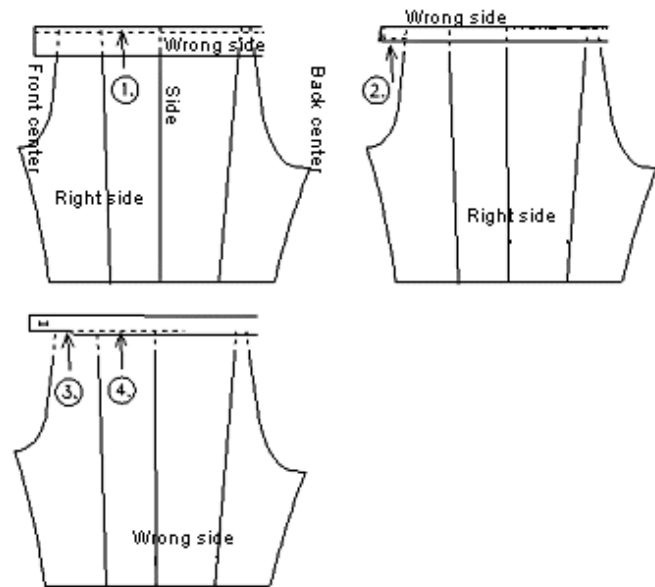

HOW TO SEW POCKETS

Flap, welt or buttonhole pocket: The techniques for these three kinds of pockets are similar. The difference lies in treatment of the pocket opening.

1. **Garment preparation:** First, decide on the width of the pocket opening, also called the pocket line or cutting line. Mark the pocket line with a pencil on the wrong side of the garment. Transfer markings to the right side with basting thread (2).
2. Cut a piece of interfacing measuring 1¼ in. (3 cm) wide and 1½ in. (4 cm) longer than pocket line. Baste or press interfacing to wrong side of garment.
3. Stitch a rectangle or "box" around pocket line as in picture (3). The edge pieces for flap, welt, or buttonhole opening are attached to the garment along this stitched "box." The rectangular "box" is about ¾ inch (2 cm) high and the length of the pocket opening.
4. Cut flap, welt, or buttonhole pieces along the straight grain of fabric, as described below. Always include seam allowances. Press interfacing to wrong side of pieces. Fold pieces as described, and place on right side of garment. With machine basting, fasten edge pieces to stitched "box" as described below.
 - a) **Flap** Cut two pieces with a finished width equal to the cutting line plus seam allowances and a finished length sufficient to cover the stitched "box." Interface. Place pocket flaps right sides together and stitch along sides. Leave raw edge to be fastened to garment. Turn piece right side out, open seams well and press. Edgestitch if desired (1).
 - b) **Buttonhole** The buttonhole pocket mouth has two narrow folded strips of fabric meeting in the center of the stitched "box."

Cut a strip of fabric, width 1½ " (4 cm) and long enough for all the pockets. For the length of the strip, multiply the length of each pocket plus seam allowances, by twice the number of pockets.

Iron interfacing to strips, fold them in half lengthwise, wrong sides together. Press lightly. Overlock raw edges of strips. Machine baste strips ¼" (6 mm) from the folded edge to mark stitching line. Place two strips on the rectangular "box," with the folded edges meeting over the pocket cutting line, and machine basting over the stitch lines of the "box." Zigzag the folded edges together to hold them in place until the pocket is completed, then remove the zigzag. Stitch rectangle again from wrong side.

- c) Welt** Cut welt piece with a length two seam allowances longer than the stitched rectangle. Welt piece height is twice the stitched box height, plus two seam allowances. Normal height of finished welt piece is ½" (1-2 cm). Interface welt, overlock raw edges and fold lengthwise wrong sides together.

Place welt on the stitched rectangle with the welt seam line along lower stitching line of "box." Folded edge faces down, and raw edge is turned upward toward the "box" center. From wrong side, stitch around "box" rectangle again.

5. **Attach pocket piece:** Cut a rectangle with width 2½ -4½ inches (4-6 cm) greater than pocket line and length twice the desired pocket depth, about 16 inches (40 cm) total (4). If you don't have enough garment fabric, the lower half can be of pocket lining fabric.
6. Pin pocket fabric to right side of garment over the pocket opening and the attached edging. Place the horizontal centerline of pocket fabric onto the upper edge of the stitched rectangle. Working from the wrong side of garment (5), stitch again over the stitched "box."
7. On wrong side of garment, slash rectangle along pocket center line and diagonally to the rectangle corners. Cut the garment and pocket material carefully along cutting line, being careful not to cut stitching (6). **DO NOT CUT POCKET FLAP, BUTTONHOLE, OR WELT pieces.**
8. Pull pocket through the opening; turn pocket to inside and press well. Edgestitch over the rectangle.
9. Turn pocket downwards, sew and overlock pocket edges (8) together. Press.
10. Turn pocket edging to its correct position on the right side of garment, press well (7). Topstitch the edging treatment as appropriate to make sure it lies flat.

PATCH POCKET WITH LINING

Note: An unlined patch pocket requires interfacing on the wrong side of pocket.

1. Cut pocket lining using the pocket pattern minus facing (1). Iron interfacing to pocket facing (2). With right sides together, stitch pocket lining to upper edge of pocket, leaving an unsewn opening about 2" (5 cm) for turning (3). Turn lining (4). Stitch sides and lower edges.
2. Trim seam. For square pocket, cut seam diagonally across lower corners. For rounded pocket, notch curves as in picture. Open seams well and press.
3. Turn pocket right side out and slipstitch opening. Topstitch upper edge about 1" (2.5 cm) from top. Pin pocket to garment. Stitch along sides and edges of pocket, simultaneously edgestitching it.

HOW TO SEW SIDE POCKETS

1. Cut 4 pieces for pockets, 2 for pocket back pieces and 2 for pocket linings.
2. Place pocket lining piece on the shell, right sides together. Sew along pocket mouth (1). Cut seam allowance diagonally (2).
3. Turn pocket lining to inside and topstitch pocket mouth (3). Place pocket back piece under pocket lining piece edges matching (4). Sew and

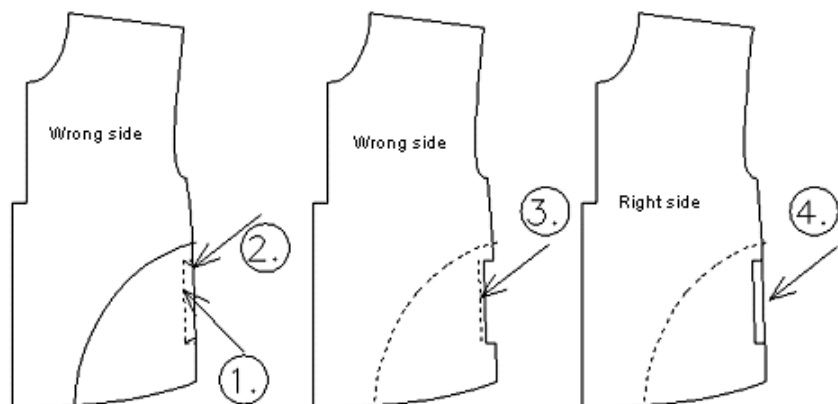

overlock along round and bottom edges. Pocket back piece is attached to side seam when sides are sewn. Be careful not to sew pocket mouth.

HOW TO SEW ZIPPER to pants and skirt

1. Sew seam to the point where zipper begins and mark zipper's full length with basting. Press the seam open. Remove basting stitches.
2. Mark front (or back) centerline with basting (1). Fold one seam allowance of zipper placket at about ¼" (0.5 cm) distance from front (or back) centerline (2). Sew one zipper edge under the extended seam allowance (3).
3. Close zipper placket temporarily with pins on right side of garment (4). On wrong side pin other

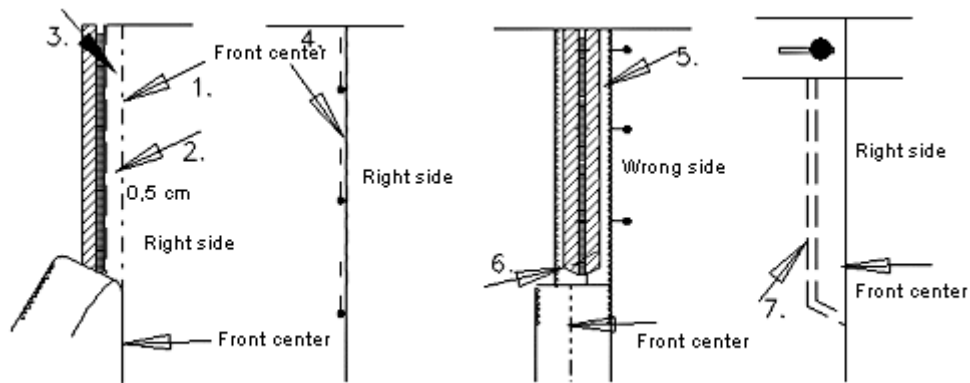

zipper edge flat on seam allowance (5). Make certain that the zipper is straight and lies flat at an even distance from edges of seam allowance. Remove pins from right side. Sew from wrong side through all thicknesses, across bottom and up the pinned edge of zipper near zipper teeth.

If you want to, you can sew a second row of stitches one presser foot's distance from the first one (7). If you are making jeans or other pants that need to be very strong, strengthen bottom of zipper placket with tight zigzag (bartack) on right side.

For an unnoticeable zipper placket:

Sew zipper directly onto garment seam, placing zipper upside down on a basted seam on wrong side of garment. The distance between the seam and the zipper stitching is the width of the presser foot. Basting is removed after sewing. This kind of a zipper is good for a dress back seam and is also widely used in skirts.

HOW TO SEW COLLARS for shirts and blouses

1. Iron interfacing to two under collar pieces (both collar band and collar) (1). Fold neckline seam allowance of collar band inwards and baste (2).
2. Sew collar together at outer edges, leaving lower edge raw. Trim seam allowance at corners.
3. Turn collar right side out, open seams well and press. Edgestitch.
4. Sew upper collar band pieces together at upper seam, sandwiching collar between them. Leave neckline edge raw. Trim seam allowance at corners and at curves. Turn collar right side out, open seams well and press.
5. Stitch collar assembly to shirt/blouse neck along raw edge, right side of collar against wrong side of shirt/blouse. Turn seam allowance up. Pin basted edge of collar on shirt's/blouse's neck to right side. Baste. Blindstitch or stitch. Edgestitch lower part of collar.

- Sew convertible collars accordingly (5). Notice that convertible collars are placed at front center of shirt/blouse and not over extension for buttons as for shirt collar.

HOW TO ATTACH COLLARS

- For the collar, cut 2 pieces of fabric and 1 piece of interfacing. The under collar piece is on the inside, hidden by the upper piece, when the garment is completed.
- Overlock button placket and front center edges. Sew front center seam from hem to where button placket begins (1). Fold button placket inwards along fold line and sew along bottom (2) and top (3) ends from fold line to front center. Cut seam allowances diagonally at point where seam ends, so that button placket can be turned right side out.

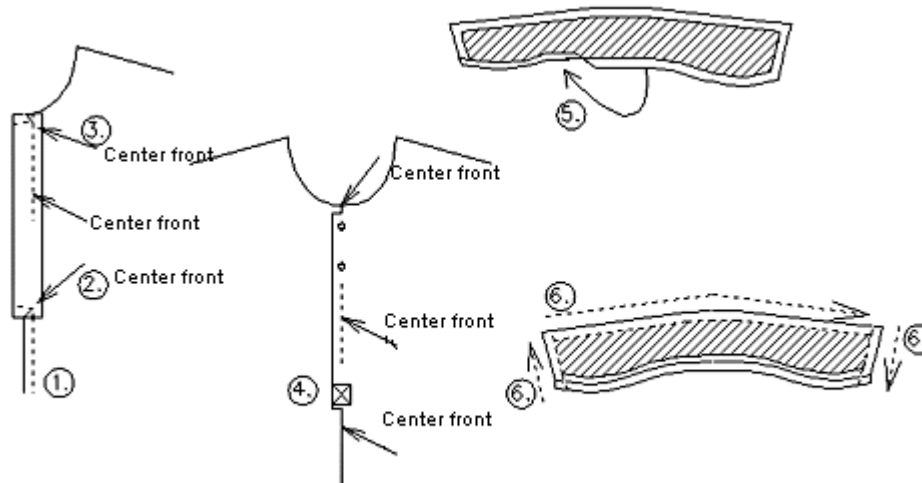

- Turn button placket right side out (4). Place button plackets' front center marks on top of each other and sew a box at bottom end of placket. Stitch through all layers of fabric.
- Iron interfacing to under collar. Turn bottom seam allowance of under collar inside and baste (5).
- Place collar pieces with right sides together and sew along edges (6). Trim seam allowances and cut corners. Turn right side out.
- Sew raw edge of upper collar to shell's neck from front center to front center, right sides together. Press seam allowance upwards and pin basted edge of under collar on top of previous seam. Sew. If you have difficulties in sewing a neat collar, sew basted edge of under collar by hand.

HOW TO SEW AND ATTACH SLEEVE CUFFS

- Fold in seam allowance of one long edge of sleeve cuff and baste (1).
- Fold cuffs horizontally in two, right sides inside, and sew along ends (2). Note that seam allowance of one edge has been folded in, but the other is unfolded, so the edges don't meet. Cut seam allowance diagonally at corners and turn cuffs right side out.

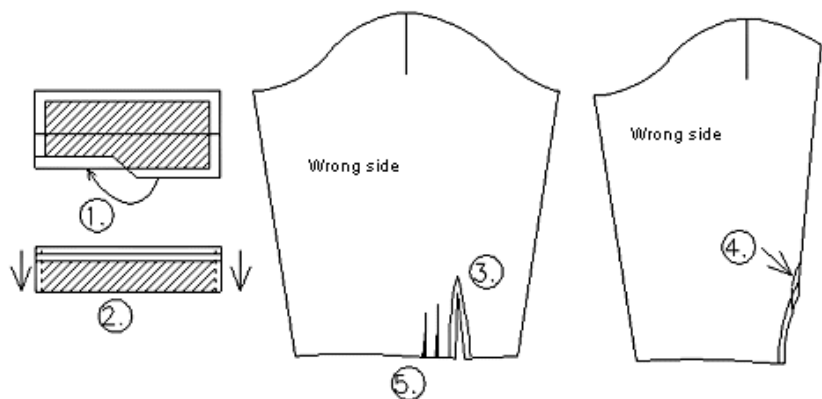

3. Cut slits at ends of sleeves and overlock edges. Turn seam allowances inside and edgestitch on right side (3). Fold slit with right side inside and sew across bottom of slit (4).
4. Fold ease of sleeve ends into soft pleats near split (5). Sew raw edges of cuffs to sleeve ends with right side of cuff against wrong side of sleeve. Turn seam allowance inside cuffs and press. Pin basted edge of cuff onto previous seam and edgestitch from right side.
5. Sew buttonholes and attach buttons to cuffs.

HOW TO SEW BACK SLIT FOR SKIRT OR DRESS

1. Overlock back center seam. Baste seam for zipper (1), sew back center seam between zipper and slit (2), and baste folding line for slit (3). Press seam open. Cut seam allowance diagonally at upper end of slit (4).
2. Fold vertical seam allowance of one half of slit inside, and edgestitch (5). Press flat (6).
3. Fold other half of slit (along right side of back centerline) inwards and sew across bottom at hemline (7).
4. Turn slit out to its correct position. Strengthen top of slit with horizontal or diagonal stitch line through all thicknesses on right side (8).

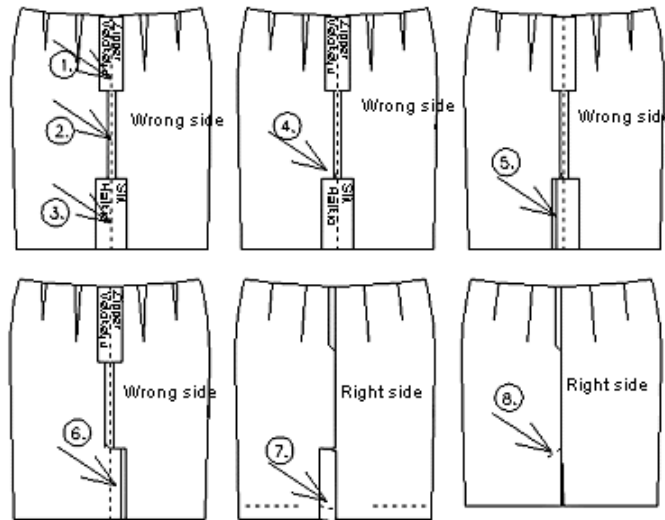

SEWING THE SKIRT

1. Cut waist band on fold.
2. Sew front and back darts (1). Sew back slit (2) according to instructions above. Sew and overlock side seams (3). Fasten zipper (4) according to instructions above.
3. Overlock back seam of lining and slit edges of hole (5). Fold seam allowances along slit inwards and edgestitch (6). Baste back seam from top to where the end of the zipper will be, and sew from there to slit hole. Press back seam open and remove zipper-basting stitches. Edgestitch zipper slit.
4. Fold waist darts to form soft pleats and pin (7). Sew and overlock side seams. Fold seam allowance for hem inside twice and sew. Make sure that the lining will be about an inch (a couple of centimeters) shorter than the skirt when both are done.

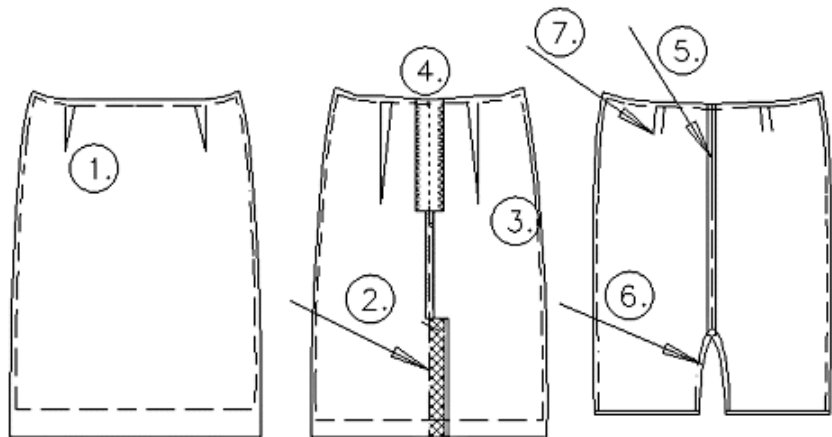

5. Place lining inside skirt and pin at waist, wrong side against wrong side and side seams matching. Easestitch waist with normal seam allowance, using your machine's longest stitches to fasten lining to skirt.
6. Fasten waistband to waist according to above instructions. Tighten or loosen waist easestitching so that waistband fits to skirt waist. The result should have no gathers or wrinkles.
7. Fold skirt hem allowance and blindstitch with machine or by hand. Sew buttonhole and fasten button.

SEWING THE BLOUSE

1. Fold front edge's seam allowances (1 cm) inwards and baste (1). Fold again, but now with right side inside along button extension fold line. Stitch button extension across top and bottom edges (2). If you are going to sew convertible collar to blouse, stitch top end from fold only to center front, and cut seam allowance diagonally there. Turn button extension to its proper position and sew along folded edge of seam allowance on wrong side.
2. Sew and overlock front dividing seams (3). Sew back shoulder and waist darts (4). Sew and overlock shoulder seams.
3. Fasten collar according to instructions above. Sew convertible collar beginning from front center, and shirt collar beginning from edge of button extension (fold).

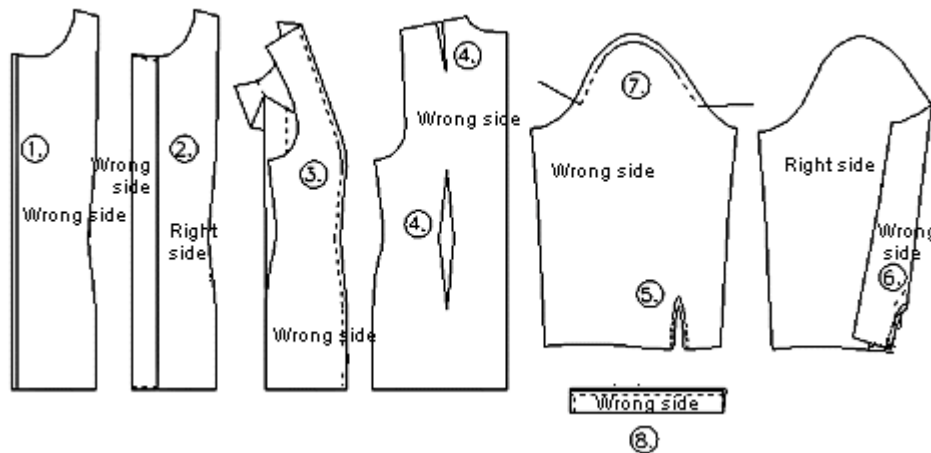

4. Cut sleeve slits at sleeve ends. Overlock slit edges, turn inwards and edgestitch (5). Stitch across end of slits on wrong side (6).
5. Easestitch sleeve cap at distance of normal seam allowance (7). Sew sleeves to armholes along ease stitching, right sides together, sleeves' shoulder mark matching blouse's shoulder seams. Pull ends of easestitching along cap to adjust ease. If there tends to be too much ease in sleeve cap (some fabrics tolerate more ease than others do), place sleeve lower at armpit. There should be as much ease as possible but no wrinkles at cap seams when ready. Overlock.
6. Sew and overlock sleeve and side seams continuously from blouse hem to sleeve end.
7. Fold in seam allowance of one long edge of sleeve cuff and baste (8). Fold cuffs horizontally in two, right sides inside, and sew along ends. Note that seam allowance of one edge has been folded in and the other is not folded, so the edges don't meet. Cut seam allowance diagonally at corners and turn cuffs right side out. Fold ease of sleeve ends into soft pleats at distance between slit and sleeve center line.
8. Sew raw edges of cuffs to sleeve ends with cuff's right side against wrong side of sleeve. Turn seam allowance inside cuffs and edgestitch basted edges to sleeves from right side.

9. Fold hem allowance twice and sew. Sew buttonholes and fasten buttons to front center and to sleeve cuffs.

SEWING A SHIRT (see picture for blouse)

Sew according to sewing instructions for blouse. Shirt, however, does not have front dividing seams or back darts.

SEWING THE PULLOVER

1. Sew and overlock shoulder and side seams (1). Sew and overlock shoulder seams of neck facing (2). Place neck facing on pullover, neck right sides together, and sew with normal seam allowance (3). Notch seam allowances at intervals of about 3/4 inch (2 cm). Turn facing inside pullover and press. Edgestitch from right side, or sew only through garment and facing seam allowances near fold line. Fasten facing to shoulder seams by hand with small stitches.

2. Easestitch sleeve caps along seam line (4). Sew and overlock sleeve seams (5). Turn sleeve right side out and pullover wrong side out. Place sleeve inside pullover (right sides together) so that sleeve shoulder mark matches with pullover shoulder seam and sleeve seam matches with pullover side seam (6). Pull ends of ease stitching along sleeve cap to adjust ease. Sew along ease stitching and overlock sleeve to pullover. If there tends to be too much ease in sleeve cap (some fabrics tolerate more ease than others do), place sleeve lower at armpit. There should be no wrinkles at cap seams when done.

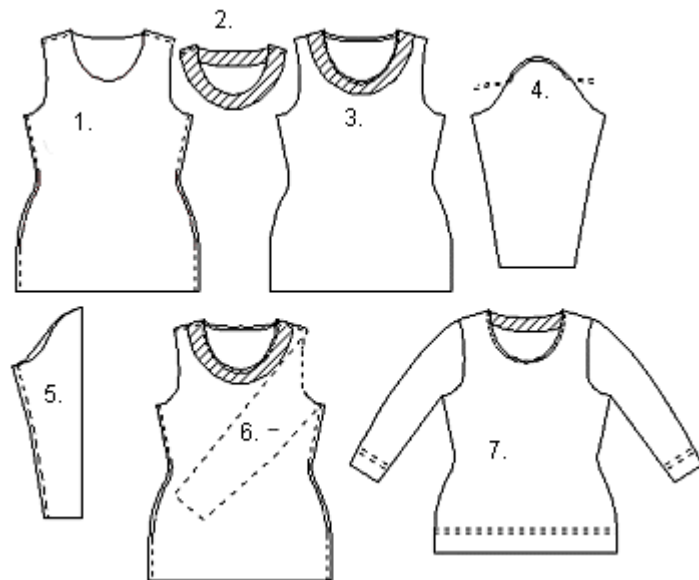

3. Fold hem and sleeve cuff allowances inside and sew with twin needle on right side of pullover. Cut excess fabric from inside near stitch line.

SEWING THE DRESS (see pullover picture)

1. Sew and overlock vertical seams at front and back pieces. Overlock back center seam (use at least 3/4" or 2 cm seam allowance to leave room to fasten zipper). Sew back seam from neck to zipper, baste for length of zipper, sew seam to back slit and baste along length of slit.
2. Sew slit according to separate instructions above.
3. Fasten invisible zipper according to separate instructions above.
4. Continue according to instructions for sewing pullover. Blindstitch hem and sleeve ends, however, with machine or by hand.

SEWING THE PANTS

Pattern pieces include:

Pants front: Cut two pieces. Two styles are available – either with darts or with pleats. Mark the darts or pleats, but do not cut them.

Pants back: Cut two pieces. Do not cut out the darts.

Waistband: Cut one on fold of fabric. Waistband piece includes a 1½” extension for button and buttonhole.

Pockets: Cut two pieces for each pocket. One piece is of trouser fabric and one of lining material.

Interfacing: Cut an interfacing piece for the waistband, using the waistband pattern cut in half lengthwise.

Lining: For trouser lining, use pants pattern pieces. Cut two front pieces and two back pieces.

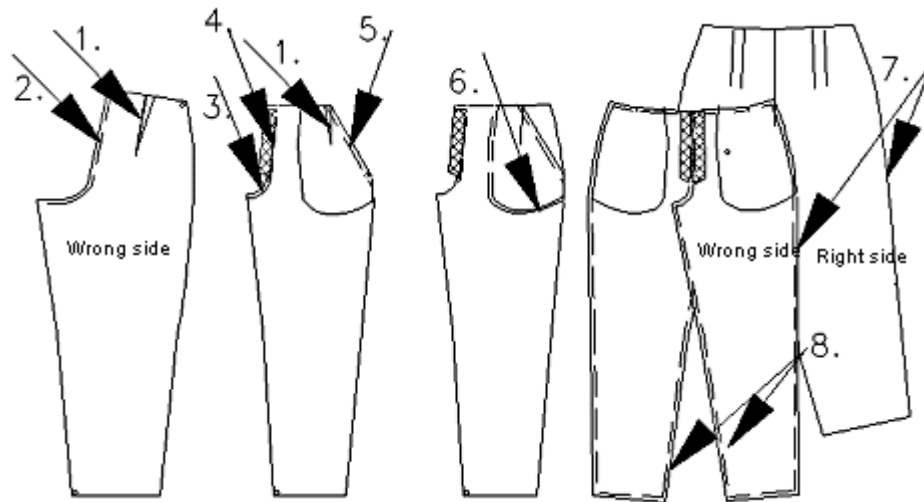

DARTS AND PLEATS (1)

To make darts in front or back, fold the dart lines with right sides together. Stitch on the dart lines. Press fold of dart toward center of garment.

To make pleats in each FRONT, bring pleat lines right sides together and pin or baste them at top.

BACK SEAM (2)

Sew and overlock back center seam, with elastic stitching if possible.

FRONT SEAM AND ZIPPER (3-4)

Overlock front center seam and edges of zipper placket. Sew front center seam from inside seam to where zipper placket begins (3).

Fasten zipper according to general instructions above.

POCKETS (5-6)

Cut front piece pocket corner off, don't forget to add seam allowance.

Put a reinforcing strip of non-elastic fabric (not included in pattern) into the seam to prevent pocket mouth from stretching during use. Place pocket lining along slacks front piece's pocket line, right sides together, and sew (5). Turn pocket lining inside and edgestitch pocket mouth. Sew another row of stitches at presser foot's width from the first row of stitches. Place pocket corner pieces under pocket lining with round edges matching. Sew and overlock them together, leaving pocket mouth open (6).

LEG SEAMS (7-8)

Place front and back sections of slacks on top of each other, right sides together. Sew and overlock outside seams. Sew and overlock inside leg seams from cuff to cuff.

LINING (optional)

Lining is optional, depending on fabric and style. For a full lining, waistband is attached to trousers and lining together. For a front lining only, handle front garment and front lining pieces as if they were one.

For a full lining, cut lining pieces using pants front and back patterns. Overlock all edges. Fold darts into pleats and baste at seam allowance. Stitch back seam. Stitch front seam from crotch to beginning of zipper placket allowance. Fold seam allowance of placket opening inside and edgestitch.

Place front and back pieces of lining right sides together; stitch together along side seams. Stitch and overlock leg inside seams from cuff to cuff. Press seam open. Fold hem border in twice and baste or pin into position.

Turn lining inside out. Pin to pants at the waist, wrong sides together with side seams matching. Attach waistband, handling pants and lining as one. Tack placket lining carefully to zipper tape, about ¼" from zipper teeth. Check hem length of lining, and stitch hem.

WAISTBAND

Fasten waistband according to general instructions above.

CUFFS

Overlock cuffs, fold cuff allowances inwards and press. Blindstitch with machine or by hand.

SEWING A JACKET

Cut upper collar 0.5 cm larger at outer edge than under collar. This will help collar to turn in to its proper position.

Use the pattern pieces as a guide in cutting lining pieces. Note that in (8) in the illustration, you need to add a pleat extension to the back lining. This extension is not given in the pattern.

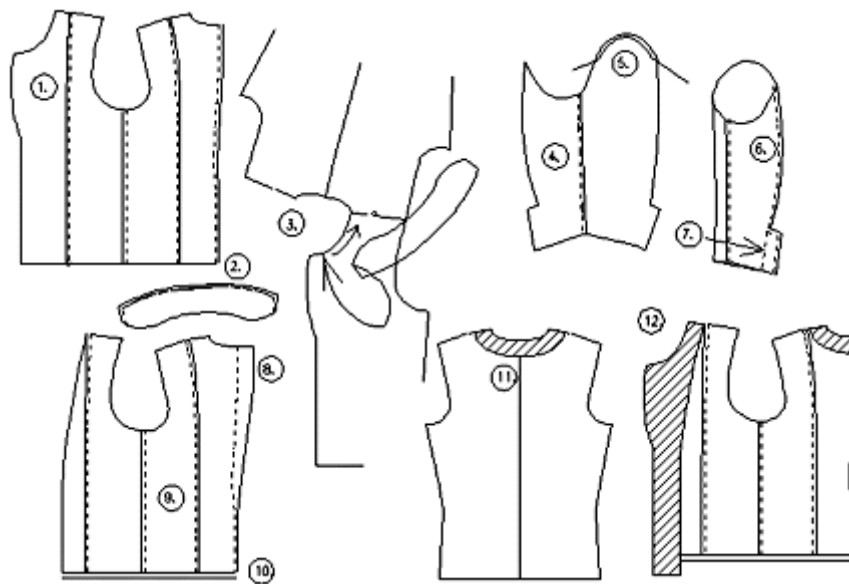

FRONT/BACK SIDE SEAMS, BACK CENTER SEAM (1)

Sew and overlock front and back dividing seams and back center seam (1). Edgestitch if desired.

Sew pockets to front pieces according your styling preferences (see general instructions).

COLLAR (2-3)

Sew upper and under collar together at edges, right sides together, (2). Trim seams and cut seam allowance at corners. Turn collar right side out and press. Edgestitch if desired. Sew collar to jacket's neck collar with center back matching jacket back center seam and collar edges matching notch marks at lapels (3).

SLEEVES (4-7)

Sew and overlock sleeve seam (4). This is the seam that will go between arm and body when the jacket is worn. Easestitch sleeve cap at distance of normal seam allowance (5). Sew sleeve upper seam from top to where button placket begins, and from there around placket at distance of normal seam allowance (6).

Baste placket fold line (7). Fold sleeve cuffs' seam allowance inside and sew with invisible stitches. Sew buttons to sleeve button plackets through all thicknesses of material.

Turn sleeve right side out and jacket wrong side out. Place sleeve inside jacket (right side against right side) so that sleeve shoulder mark matches with jacket shoulder seam and seam between the two sleeve pieces matches with jacket side seam. Pull on easestitching in sleeve cap to adjust cap ease. Sew and overlock sleeve cap to jacket. If there tends to be too much ease in sleeve cap (some fabrics tolerate more ease than others do), place sleeve lower at armpit. There should be as much ease as possible but no wrinkles at cap seams when done.

LINING (8-11)

Cut extra width to upper part of lining's back (8). Sew lining pieces together, right sides together (9). Fold hem inside twice and sew (10). Zigzag back neck facing to the neck of back lining with lining's wrong side against linings right side (11).

JOIN JACKET AND LINING (12)

Fasten jacket's front facing to lining's front edges, right sides together (12). Overlock. Sew and fasten sleeves to lining as you did to jacket.

To join jacket and lining, place them on top of each other, right sides together. Put collar between jacket and lining. Sew continuously as follows: across front facing hem, along one front edge, around neckline to other front edge and finally across other front facing hem. Cut seam allowance at starting point of lapels and neck seam at intervals of $\frac{3}{4}$ " inch (2 cm). Cut corners diagonally. Turn lining inside jacket. Open seams and press well. Edgestitch if desired.

Sew buttonholes and fasten buttons to jacket. Do final pressing.

LBODICE.MAC

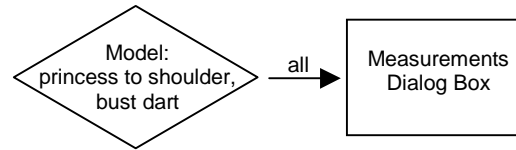

LBLOUSE.MAC

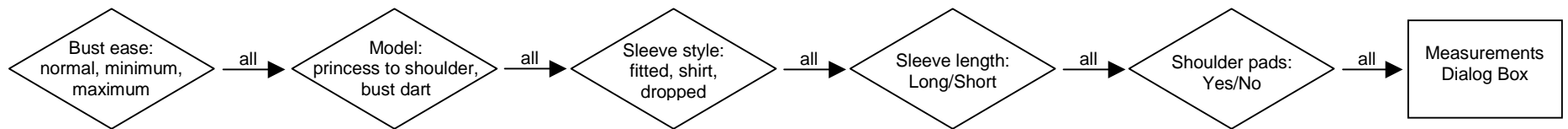

LDRESS.MAC

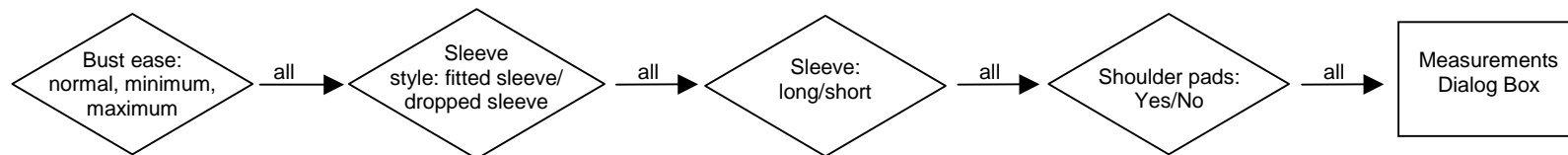

LCOLLAR.MAC

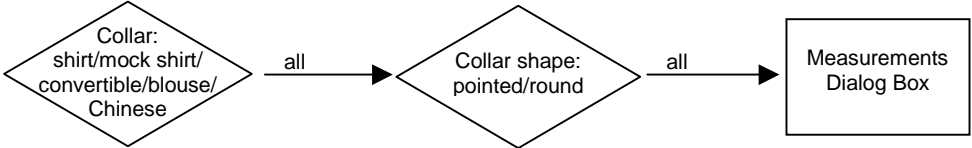

LJACKET.MAC

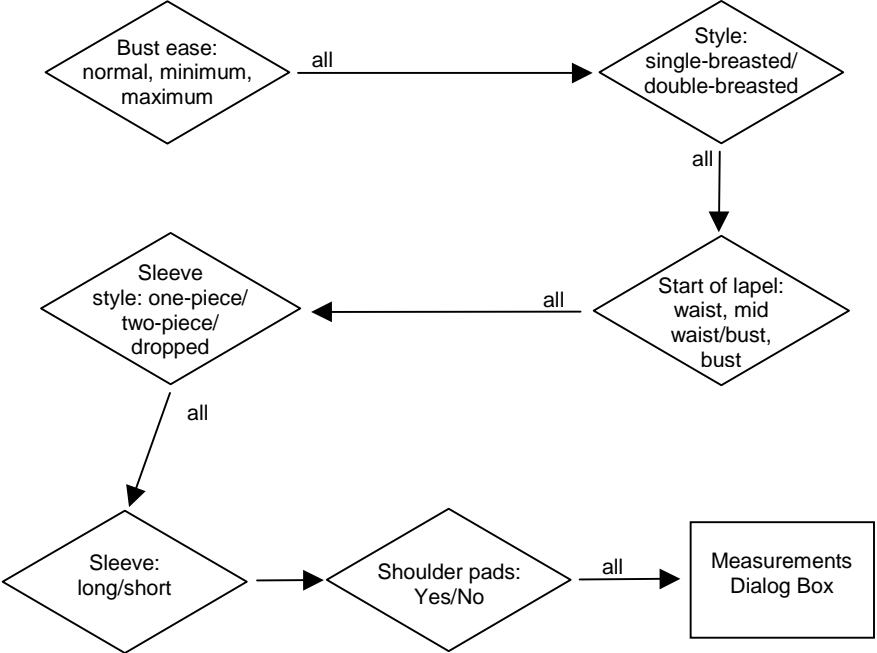

LPULLOV.MAC

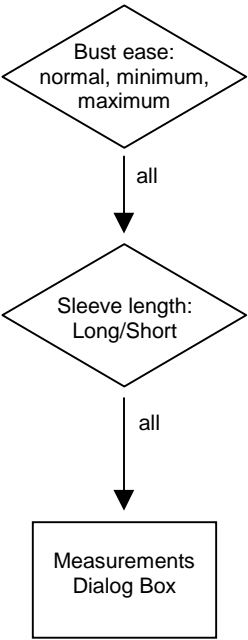

LPANTS.MAC

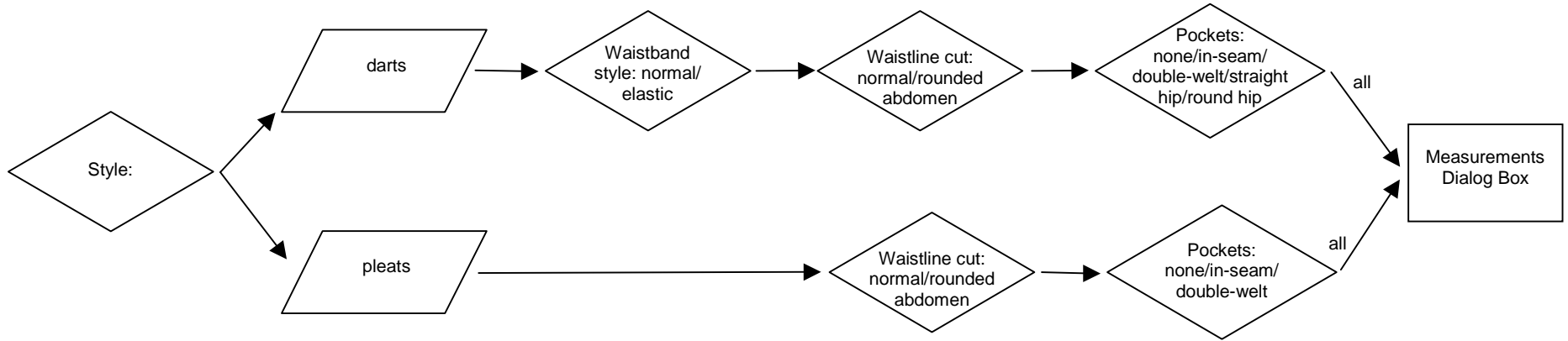

LSHIRT.MAC

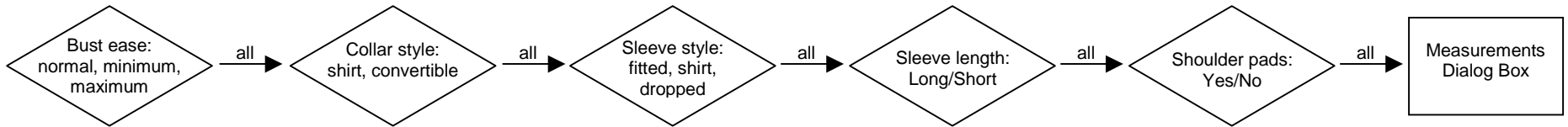

LSKIRT.MAC

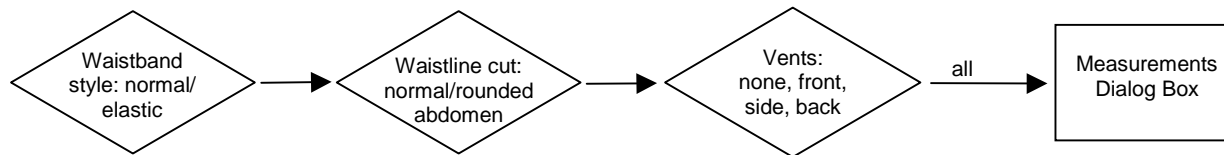

PatternMaker Software

Measuring for Women's Macros

1. neck circumference
2. bust circumference
3. waist circumference
4. abdomen circumference
5. hip circumference
6. bust span
7. bust height
8. waist height
9. back length
10. back width
11. shoulder
12. waist-abdomen
13. waist-hip
14. biceps
15. wrist circumference
16. overarm
17. outside seam
18. crotch depth

Measure bust height (7) and waist height (8) around neck (double) and divide by 2.

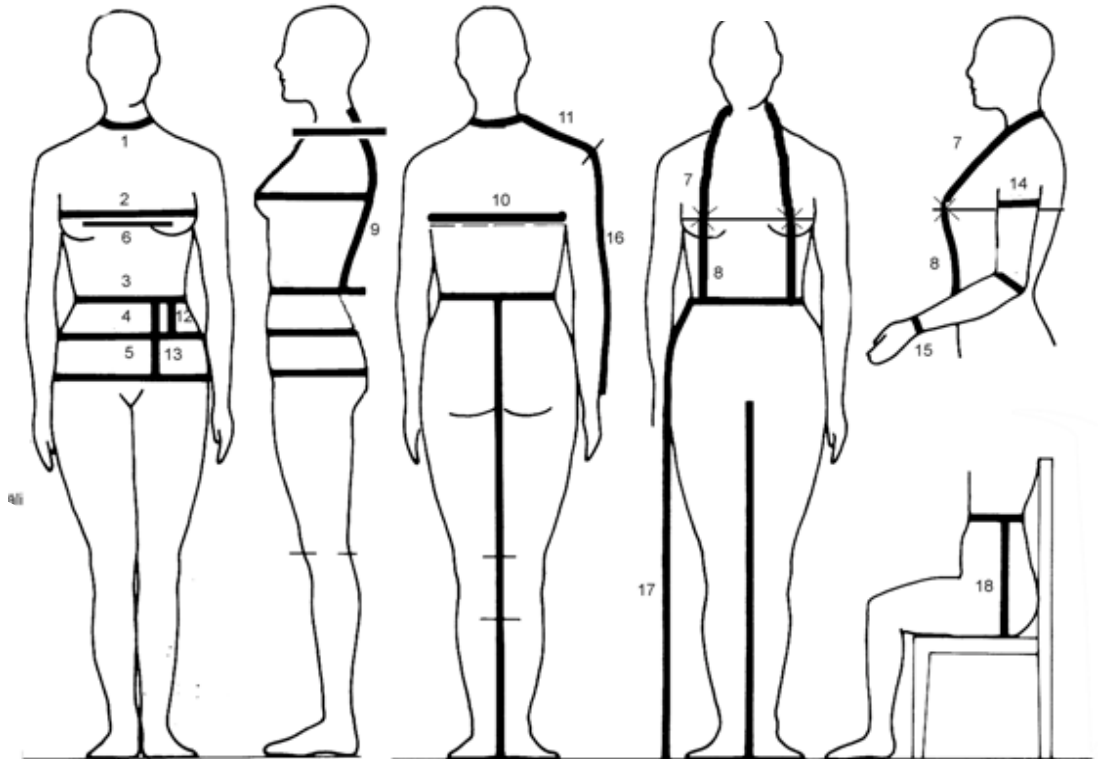

Following are the instructions on how to measure for PatternMaker women's macros.

Don't try to take the measurements yourself. Ask someone else to take them. Stand straight but relaxed when you are being measured. You will receive the best results if the measurements are taken over underwear.

Place 1-inch wide elastic bands around your waist and hip. Search carefully for the correct places of these elastic bands. Keep these elastic bands on their places during the whole measuring process. Hip elastic is fastened on the level where hip circumference is maximum. Examine whether it is on your buttocks (7-8 inches/18-20 cm below the waist) or on top of your thighs (10-12 inches/25-30 cm below the waist). Measurements are taken from the bottoms of the bands.

Except for pants' cuff circumference and skirt/dress length, all measurements are body measurements. **DO NOT ADD ANY EASE** to the measurements. The program does it for you.

DO NOT TIGHTEN MEASURING TAPE.

Please, refer to the picture related to this measuring form.

BE ESPECIALLY CAREFUL WHEN TAKING THE MEASUREMENTS WRITTEN IN CAPITAL LETTERS.

They are crucial for good fitting patterns. After having taken all the measurements, take these important measurements once again.

You can use either centimeters or inches. Give inches in fractions.

PatternMaker Software

Women's Measuring Chart

Name: _____

Date: _____

1	Neck Circumference: Measure around lowest part of neck, at the base	
2	Bust Circumference: Marked with elastic. Measure around the fullest part of the bust, keeping the tape high at the back	
3	Waist Circumference: Measure waist at the elastic tape	
4	Abdomen Circumference: Measured on the level where abdomen circumference is maximum	
5	Hip Circumference: Measured over the largest part of your bottom/thighs (at elastic)	
6	Bust Span: Horizontal distance between bust apexes (also called bust bridge). Measured along bust elastic.	
7	Bust Height: Measure from center of back neck over shoulder to apex of one breast	
8	WAIST HEIGHT: Measure from center of back neck over shoulder to breast apex and from there vertically to lower edge of waist elastic. To be sure to get right measurements, take this and bust height as a link around neck (=double) and divide the result by 2 (see picture).	
9	BACK LENGTH: Measure from center of back neck to lower edge of waist elastic	
10	BACK WIDTH: hang your arms relaxed on your sides. The measurement is taken horizontally between shoulder blades (i.e. from sleeve seam to sleeve seam), from and to the point where your arm meets your body (but not to armpit) about 4" (10 cms) from neck downwards.	
11	Shoulder length: Measure from neck to shoulder tip. Shoulder tip is found when you raise your arm to horizontal position and feel where there is hollow/pit between shoulder and arm bones. Hold your arm horizontal, if necessary, to find this point.	
12	Waist-Abdomen: Measure vertically from lower edge of waist elastic to lower edge of abdomen elastic. Measure at front center.	
13	Waist-Hip: Measure vertically from lower edge of waist elastic to lower edge of hip elastic. Measure at the side.	
14	Biceps circumference: Measure at widest point of upper arm.	
15	Wrist circumference: Measure over wrist bone	
16	Overarm: Arm length from shoulder tip (as described above) to wrist. Bend arm slightly and measure over outside of elbow.	
17	Outside seam: Measure from waist over the outside curvature of the hip to the desired cuff length.	
18	CROTCH DEPTH: Sit on <i>unpadded</i> bench or chair. Measure vertically from waist elastic to chair level on both sides, and use the longer measurement. Measure in a straight line, not along the outside hip curve. (Crotch depth can also be measured from a pair of old, well fitting pants.) Crotch depth is the difference between outside and inside length of pants.	
	Desired cuff circumference, not ankle circumference	
	Desired jacket length from waist elastic to hem	
	Desired skirt /dress length from waist elastic to hem	

Important things to be taken into consideration when measuring

The most important measurements are the ones written in on the measuring chart in **BOLD CAPITAL LETTERS**: waist height, back length, back width, and pants' crotch depth.

If one of these four measurements is wrong, the result may be a distorted pattern and it is difficult to figure what measurement is wrong. If some other measurement is wrong, you get either a too-tight or a too-loose garment and you can easily see what measurement to correct and to what direction.

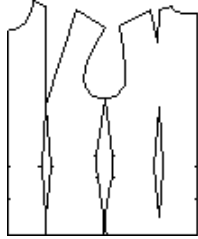

Figure 3: normal sloper

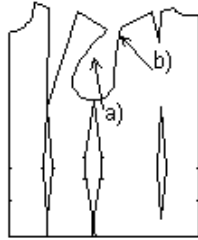

Figure 2: back width wrong

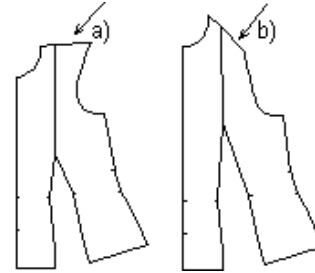

Figure 1: waist height/back length wrong

Normally the pattern for basic sloper is more or less like Figure 1. Front and back shoulders slope downwards to shoulder tip. Armscyes curve inward. Back armscye can be rather straight but should never bulge outward.

If the pattern is like in Figure 2 -- i.e. front armscye curves strongly inward (a) and back armscye bulges outward (b), back width has been measured wrong and is too much. Measure back width anew.

Please note that this measuring error causes the garment to be too loose at back and too tight at front. Therefore the situation cannot be corrected by only reducing width of back piece. The pattern must be redrawn using the correct back width measurement.

If waist height in relation to back length is wrong (refer to Figure 3), the result is either a shoulder that slopes to wrong direction (a) or a shoulder which is too steep (b). If you measure waist height as instructed in PatternMaker measuring instructions i.e. double around back neck and divide the result by 2, there seldom is any error in waist height. Therefore the error usually is in back length.

If shoulder slopes in wrong direction (a), back length is too much and if shoulder is too steep (b), back length is too little. Change back length 2-3 cm in the needed direction and see if it is enough to correct the situation. If it looks good, you see to which point at neck back length has to be measured to be OK.

If the subject stands in a very upright, military position with bust out and abdomen in, also waist height may be too much. Please make sure that the subject stands in a relaxed position when she is being measured.

In some cases a steep shoulder may be due to the subject's body shape. This is the case if the subject has a very prominent bust. And conversely, if a subject has a very flat bust and/or a very round back, the shoulder can be rather straight.

Thus, there are cases, where the patterns are all right even if they look "odd". When the patterns are drawn according to a person's own measurements, they should not be compared with patterns drawn according to "normal" or "average" measurements. If you are not sure of the measurements taken, you have a very good and simple way to check them: sew a muslin with the basic bodice patterns. If it fits on the subject, you can be sure that all other garments sewn with PatternMaker macros will fit well.

If you get an error message:

```
value out of range in line ...  
coord (32,33,sqrt(op*op-oke*oke),-oke);
```

it means the measuring error is so drastic that the program is unable to draw the patterns at all. Front shoulder does not meet armscye line. Then either back length is too little or waist height too much. It may also be that shoulder length has some influence: shoulder length may be too short.

Also, in some other cases there may be reason for checking shoulder length measurement. If shoulder is too short, there will be a corner inward where front and back shoulder meet at shoulder tip and vice versa.